



Distributed by
Centre Tank Services Ltd.
Unit 41, Minworth Industrial Park,
Forge Lane, Minworth, Sutton
Coldfield, West Midlands B76 1AH

Telephone: 0121 351 4445 –
Fax: 0121 351 4442



Email: sales@centretank.com
Website: www.centretank.com



Instruction Manual

Pneumatic tank contents gauge Unitop

Unitop 1200	# 28016
Unitop 3000	# 28015
Unitop 4000	# 28017

-  Read manual before use!
-  Observe all safety information!
-  Keep manual for future use!

Contents

1	About this instruction manual.....	3
1.1	Structure of warning	3
1.2	Explanation of symbols and typeface.....	3
2	Safety.....	4
2.1	Intended use	4
2.2	Predictable incorrect application	4
2.3	Safe handling.....	4
2.4	Modifications to the product.....	5
2.5	Use of spare parts and accessories	5
2.6	Liability information.....	5
3	Product description	6
4	Specifications.....	7
5	Installation and commissioning.....	8
5.1	Installing the device	8
5.2	Adjusting the measuring range and the Zero correction	9
5.3	Installing capillary line.....	10
6	Operation	11
7	Maintenance	11
8	Troubleshooting	12
9	Spare parts and accessories	13
10	Warranty	13
11	Copyright.....	13
12	Customer satisfaction	13
13	Addresses	13
14	Appendix	13
14.1	Determining the measurement range.....	13



1 About this instruction manual

This instruction manual is part of the product.

- ▶ Read this manual before using the product.
- ▶ Keep this manual during the entire service life of the product and always have it readily available for reference.
- ▶ Always hand this manual over to future owners or users of the product.

1.1 Structure of warning

WARNING TERM The type and source of danger is shown here.



- ▶ Precautions to take in order to avoid the danger are shown here.

There are three different levels of warning:

Warning term	Meaning
DANGER	Imminent danger! Failure to observe the information will result in death or serious injuries.
WARNING	Possible imminent danger! Failure to observe the information may result in death or serious injuries.
CAUTION	Dangerous situation! Failure to observe the information may result in minor or serious injuries as well as damage to property.

1.2 Explanation of symbols and typeface

Symbol	Meaning
<input checked="" type="checkbox"/>	Prerequisite for an activity
▶	Activity consisting of a single step
1.	Activity consisting of several steps
↪	Result of an activity
•	Bulleted list
Text	Indication on a display
Highlighting	Highlighting



2 Safety

2.1 Intended use

The pneumatic tank contents gauge Unitop is exclusively suitable for the level measurement of the following liquids:

- Fuel oil EL according to DIN 51603-1
- Diesel fuel according to EN 590
- Fatty acid methyl ester (FAME) as a fuel oil according to EN 14213
- Fatty acid methyl ester (FAME) as biodiesel according to EN 14214
- Inflammable liquids of danger class AIII and non-inflammable liquids which meet the following requirements:
 - The fumes of the liquid do not attack plastics (PA, PS, PE) or Cu-, Zn- and Sn-alloys or elastomers.
 - The liquid is not classified as hazardous class A1, AII or B.
 - Kinematic viscosity < 300 mm²/s.

Any use other than the use explicitly stated in this instruction manual is not permitted.

2.2 Predictable incorrect application

The pneumatic tank contents gauge Unitop must never be used in the following:

- Level measurement of liquids other than those listed above.
- Hazardous areas (ex)
If the device is operated in hazardous areas, sparks may cause deflagrations, fires or explosions

2.3 Safe handling

This product represents state-of-the-art technology and is manufactured in accordance with the pertinent safety regulations. Each unit is subjected to a function and safety test prior to despatch.

- ▶ Operate the product only when it is in perfect condition. Always observe the instruction manual, all pertinent local and national directives and guidelines as well as health and safety regulations and directives regarding the prevention of accidents.

Extreme environmental conditions have negative effects on the function and accuracy of the product.

- ▶ Protect Unitop from shocks.
- ▶ Protect Unitop from atmospheric influences and direct sunlight.



2.4 Modifications to the product

Changes or modifications made to the product by unauthorised persons may lead to malfunctions and are prohibited for safety reasons.

2.5 Use of spare parts and accessories

Use of unsuitable spare parts and accessories may cause damage to the product.

- ▶ Use only the manufacturer's genuine spare parts and accessories (refer to chapter 9, page 13).

2.6 Liability information

The manufacturer shall not be liable for any direct or consequential damage resulting from failure to observe the technical instructions, guidelines and recommendations.

The manufacturer and the sales company shall not be liable for costs or damages incurred by the user or by third parties in the use or application of this device, particularly in case of improper use of the device, misuse or malfunction of the connection, malfunction of the device or of connected devices. The manufacturer or the sales company shall not be liable for damages resulting from any use other than the use explicitly stated in this instruction manual.

The manufacturer shall not be liable for misprints.



3 Product description

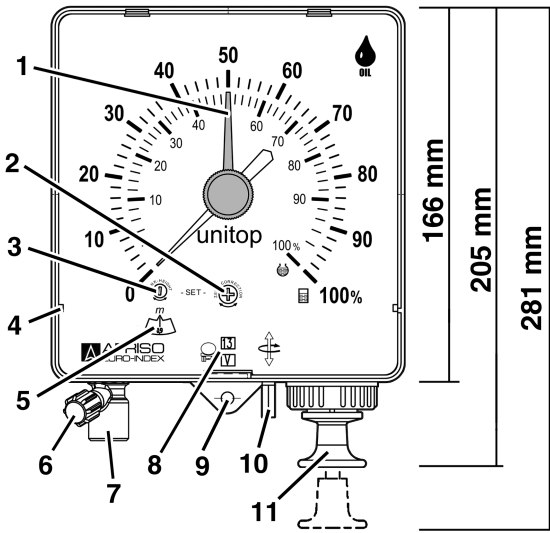

- 1 Red reference pointer
- 2 Adjustment screw for Zero point correction
- 3 Adjustment screw for measuring range
- 4 Support for additional slide-in scale
- 5 Adjustment scale for measuring range
- 6 Vent cap
- 7 Capillary connection
- 8 Manual date indicator
- 9 Fixing lug
- 10 Adjustment pin for date indicator
- 11 Pump plunger

Fig. 1: Front view Unitop

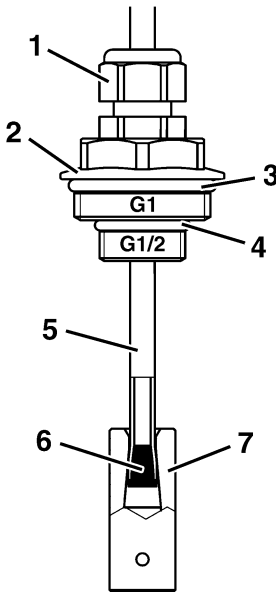

- 1 Cable gland PG9
- 2 Screw-in tank adapter G $\frac{1}{2}$ -G1
- 3 O ring \varnothing 30 x 3 mm
- 4 O ring \varnothing 18 x 2,5 mm
- 5 Stand pipe
- 6 Conical washer
- 7 Balance chamber

Fig. 2: Tubing kit



Unitop measures the hydrostatic liquid pressure at the tank bottom. The pressure varies according to liquid height and specific gravity of the medium to be measured. The pressure is measured approx. 20 mm above the tank bottom and displayed on the gauge dial.

When operating the pump of the Unitop a pneumatic pressure is built up in the capillary measuring line until that pressure is equal to the liquid head pressure at the bottom of the tank. The pressure created by the pump has displaced the liquid in the capillary tubing inside the tank and the air bubbles out of the end of the standpipe in the tank. The pointer has reached its highest indication point and stops at that level.

Unitop enables the user to obtain a relatively accurate consumption control thereby allowing a timely reordering of fuel. The driver of the oil delivery vehicle can use Unitop to check whether the tank can accept the ordered quantity of fuel.

We recommend the use of the Pneumofix mounting kit including standpipe, capillary tubing, reducers, condensate trap, hose extension connector and hose clips. See chapter 9, page 13.

4 Specifications

Table 1: Specifications

Parameter	Value
General	
Dimensions housing (W x H x D)	155 x 166 x 73 mm
Weight	0.6 kg
Measuring range	Fully adjustable, for measurement of fuel oil EL or diesel fuel with an average density of 840 kg/m ³ at +15 °C:
Unitop 1200	700-1200 mm tank height
Unitop 3000	900-3000 mm tank height
Unitop 4000	3000-4000 mm tank height
Mechanism	Linear capsule type, overpressure protected
Accuracy	± 2 % of full scale value
Indication	Standard: 0-100 %-liquid height for rectangular and horizontal cylindrical tanks For additional slide-in scales with indication in litres for standardised tanks as well as special slide-in scales see chapter 9, page 13.



Parameter	Value
Material	
Housing	Plastic ABS
Front glass	Plastic SAN
Measuring system	Brass
Operating temperature range	
Ambient	-5 °C to +55 °C
Standpipe (wetted part in contact with liquid)	
Material	The standpipe must be resistant to the liquid to be measured. The material must not be attacked by the liquid. Example: For heating oil EL, diesel fuel and FAME: Pneumofix standpipe (NBR), copper tubing or oil resistant Perbunan-N-capillary tube with weight as distance piece.
Internal diameter	4 mm for fuel oil EL, L , M, diesel fuel, FAME, liquids with a kinematic viscosity up to 90 mm ² /s 6 mm for liquids with a kinematic viscosity up to 190 mm ² /s 8 mm for liquids with a kinematic viscosity up to 300 mm ² /s
Measuring line	
Length	Max. 50 m
Type	Pneumofix measuring line (PE), copper tubing 6 mm (outer-Ø) x 1 mm or PE-capillary 4 mm (internal-Ø) x 1 mm

5 Installation and commissioning

5.1 Installing the device

1. Drill two holes at the same height at a distance of 13 cm.
2. Fit the enclosed dowels and screw in the screws up to approx. 1.5 cm.
3. Hang Unitop onto the two screws and pull down slightly.
 The fixing lug is flush at the wall.
4. Fasten Unitop to the wall with the third screw.

5.2 Adjusting the measuring range and the Zero correction

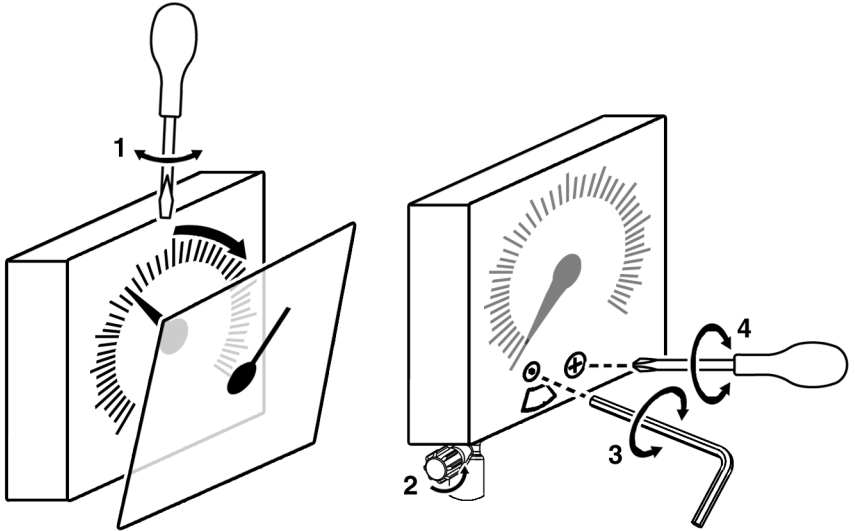

The accuracy of the gauge measurement is dependent on the exact adjustment of the measuring range and the Zero correction.

- To adjust the zero point, the system must not be under pressure: The measuring line is not yet connected or open the the vent cap (2).
- 1. Determine measuring range:
 Fuel oil EL and diesel fuel: Measuring range = Tank height.
 Other liquids: See page 14.
- 2. Remove front glass (1).
- 3. Adjust measuring range accurately (3).
- 4. Tap housing gently on the side.
- 5. Adjust Zero correction (4): Set pointer to "0" by turning screw either to the left or right by maximum 1 full turn.
- 6. If applicable, insert slide-in-scale and then refit front glass.
- 7. Close the vent cap.



5.3 Installing capillary line

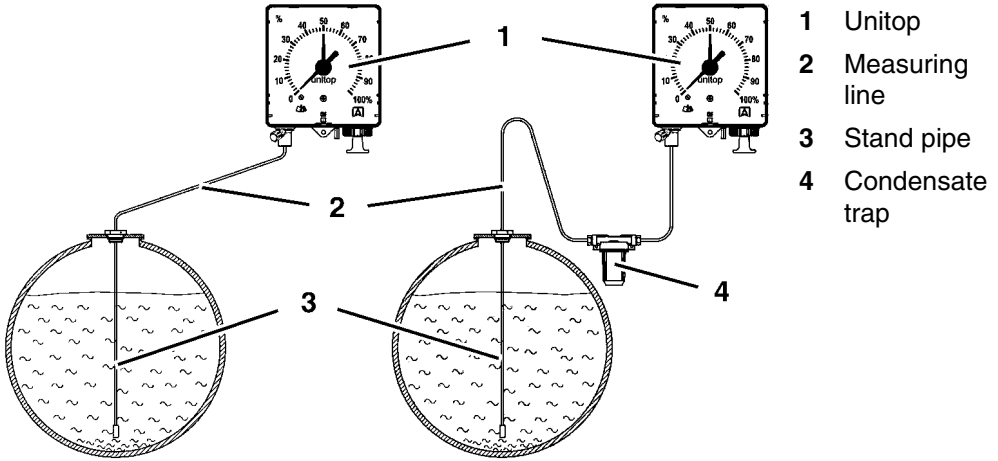
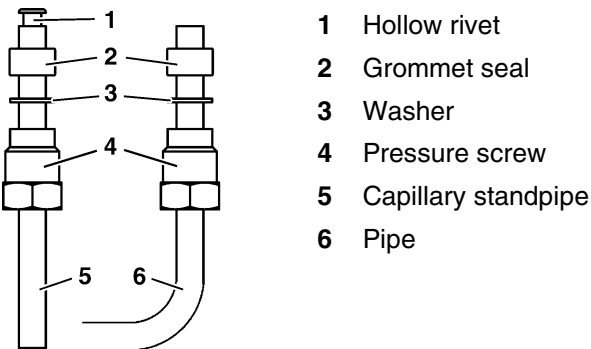

Fig. 3: Unitop without (left) and with condensate trap (right)

If no separate gauge connection socket is provided on the tank, it is possible to combine a number of capillary lines by connecting a Euroflex 3 combination fitting to a G1"-socket on the tank.

1. Fix standpipe such that the lower end of the capillary tube ends approx. 2 cm above the lowest point of the tank bottom.
2. Install capillary line with a steady slope towards the tank, avoiding any kinks or possible water traps in the line.
3. Install a condensate trap if Unitop is mounted below the max. liquid level in the tank or in a place where condensate may collect.
4. Push connector onto capillary tube.



5. Insert capillary line into connector and push in to the stop.
6. Tighten pressure screw gently.



7. Connect standpipe to capillary line, using for instance a hose connector.

6 Operation

Unitop provides a semi-permanent indication. The built-in pump closes off the measuring line when it reaches the end of its travel, the pointer stays temporarily at its last reading and then drops back very slowly. As a result of this the gauge mechanism is protected by an air cushion.

Do not operate gauge during a tank filling operation as the gauge will not give a stable reading.

Vent cap is closed.

1. Pull out pump plunger to its stop and then release.
2. Repeat this process until the indication is stable.
3. Read tank contents on the dial of the gauge.

If the capillary measuring line has been installed absolutely airtight the pointer of the gauge will continue to show the last reading over a long period of time. In order to obtain an accurate up-to-date reading we recommend that you operate the pump everytime before a reading is taken.

The red reference pointer can be adjusted manually. When set to the latest reading it serves for consumption control purposes.

The date indicator can be adjusted manually, e.g. in order to mark the date of the most recent tank filling.

- ▶ Setting the day: Push the adjustment pin to the top and turn it.
- ▶ Setting the month: Push the adjustment pin down and turn it.

7 Maintenance

Table 2: Maintenance intervals

When	Activity
Condensate trap contains water.	▶ Empty condensate trap.
At time of tank servicing or tank cleaning.	▶ Check Unitop for correct function and, if necessary, have the instrument re-adjusted.



8 Troubleshooting

Repair work may only be carried out by qualified, specially trained personnel.

Table 3: Troubleshooting

Problem	Possible reason	Remedy
Pointer does not move when pump is operated or drops back again very quickly.	Connections are not airtight or the capillary lines are damaged and leaking.	▶ Tighten connections and check capillary lines for air tightness.
	Filling process.	▶ Take measurement after the tank filling process.
Pointer goes beyond the 100 % mark or pump does not return fully to its stop.	Capillary line is either blocked or has a kink in it.	▶ Check that capillary line has no kinks in it and clear any blockage. ▶ Install condensate trap.
	Condensate trap full.	▶ Empty condensate trap.
	The wrong measuring range has been adjusted.	▶ Check tank dimensions and correct measuring range, see chapter 5.2, page 9.
Wrong indication.	Measuring range adjusted wrongly.	▶ See above.
	Zero correction not correctly set.	1. Open the vent cap so the system is not under pressure. 2. Reset Zero correction, see chapter 5.2, page 9.
Other malfunction.	–	▶ Return the device to the manufacturer.



9 Spare parts and accessories

Part	Part No.
Universal mounting kit Pneumofix	20153
Combination fitting Euroflex 3 with capillary tubing 2,15 m	20160
Combination fitting Euroflex 3 with capillary tubing 3,15 m	20164
Montagefix-extension set (10 m PE-capillary tubing 4 x 1 mm with capillary extension piece)	20132
Additional slide-in scales in litres for standardised tanks	725...
▶ When ordering, please specify the shape and capacity of tank.	
Special slide-in scales for tanks of any shape and dimension	72599
▶ When ordering, please specify exact tank shape, size and capacity.	

10 Warranty

The manufacturer's warranty for this product is 24 months from date of purchase. This warranty applies to all countries in which this product is sold by the manufacturer or its authorised representatives.

11 Copyright

The manufacturer holds the copyright to this manual. This manual may only be reprinted, translated, copied in part or in whole with the prior written consent of the manufacturer.

We reserve the right to modify any specifications or alter any illustrations in this manual without prior notice.

12 Customer satisfaction

Customer satisfaction is our prime objective. Please get in touch with us if you have any questions, suggestions or problems regarding your product.

13 Addresses

The addresses of our worldwide representatives can be found on the Internet at www.afriso.com.

14 Appendix

14.1 Determining the measurement range



Tank height [mm]	Specific gravity (density) of liquid to be measured [kg/m ³]															
	700	720	740	760	780	800	820	840	860	880	900	920	940	960	980	1000
600															0,70	0,71
650											0,70	0,71	0,73	0,74	0,76	0,77
700								0,70	0,72	0,73	0,75	0,77	0,78	0,80	0,82	0,83
750					0,70	0,71	0,73	0,75	0,77	0,79	0,80	0,82	0,84	0,86	0,88	0,89
800			0,71	0,72	0,74	0,76	0,78	0,80	0,82	0,84	0,86	0,88	0,90	0,91	0,93	0,95
850	0,71	0,73	0,75	0,77	0,79	0,81	0,83	0,85	0,87	0,89	0,91	0,93	0,95	0,97	0,99	1,01
900	0,75	0,77	0,79	0,81	0,84	0,86	0,88	0,90	0,92	0,94	0,96	0,99	1,01	1,03	1,05	1,07
950	0,79	0,81	0,84	0,86	0,88	0,91	0,93	0,95	0,97	1,00	1,02	1,04	1,06	1,08	1,11	1,13
1000	0,83	0,86	0,88	0,90	0,93	0,95	0,98	1,00	1,02	1,05	1,07	1,10	1,12	1,14	1,17	1,19
1100	0,92	0,94	0,97	1,00	1,02	1,05	1,07	1,10	1,13	1,15	1,18	1,20	1,23	1,26	1,28	1,31
1200	1,00	1,03	1,06	1,08	1,11	1,14	1,17	1,20	1,23	1,26	1,29	1,31	1,34	1,37	1,40	1,43
1250	1,04	1,07	1,10	1,13	1,16	1,19	1,22	1,25	1,28	1,31	1,34	1,37	1,40	1,43	1,46	1,50
1300	1,08	1,11	1,14	1,18	1,21	1,24	1,27	1,30	1,33	1,36	1,39	1,42	1,45	1,48	1,52	1,55
1400	1,17	1,20	1,23	1,27	1,30	1,33	1,37	1,40	1,43	1,47	1,50	1,53	1,57	1,60	1,63	1,65
1500	1,25	1,28	1,32	1,36	1,39	1,43	1,46	1,50	1,54	1,57	1,60	1,64	1,68	1,71	1,75	1,79
1600	1,33	1,37	1,41	1,45	1,48	1,52	1,56	1,60	1,64	1,67	1,70	1,75	1,80	1,83	1,85	1,90
1700	1,42	1,46	1,50	1,54	1,58	1,62	1,65	1,70	1,75	1,78	1,82	1,85	1,90	1,95	1,98	2,00
1800	1,50	1,54	1,59	1,63	1,67	1,70	1,75	1,80	1,85	1,89	1,93	1,95	2,00	2,05	2,10	2,15
1900	1,58	1,63	1,67	1,72	1,75	1,80	1,85	1,90	1,95	2,00	2,08	2,12	2,10	2,15	2,20	2,25
2000	1,67	1,70	1,75	1,80	1,85	1,90	1,95	2,00	2,05	2,10	2,15	2,20	2,25	2,30	2,35	2,40
2100	1,75	1,80	1,85	1,90	1,95	2,00	2,05	2,10	2,15	2,20	2,25	2,30	2,35	2,40	2,45	2,50
2200	1,85	1,90	1,95	2,00	2,05	2,10	2,15	2,20	2,25	2,30	2,35	2,40	2,45	2,50	2,55	2,60
2300	1,95	2,00	2,05	2,10	2,15	2,20	2,25	2,30	2,35	2,40	2,45	2,50	2,55	2,60	2,65	2,70
2400	2,00	2,05	2,10	2,15	2,20	2,30	2,35	2,40	2,45	2,50	2,55	2,60	2,70	2,75	2,80	2,85
2500	2,10	2,15	2,20	2,25	2,30	2,40	2,45	2,50	2,55	2,60	2,70	2,75	2,80	2,85	2,90	3,00
2600	2,20	2,25	2,30	2,35	2,40	2,50	2,55	2,60	2,65	2,70	2,80	2,85	2,90	2,95	3,00	3,10
2700	2,25	2,30	2,40	2,45	2,50	2,55	2,65	2,70	2,75	2,85	2,90	2,95	3,00	3,10	3,15	3,20
2800	2,35	2,40	2,45	2,55	2,60	2,65	2,75	2,80	2,85	2,95	3,00	3,10	3,15	3,20	3,25	3,35
2900	2,45	2,50	2,55	2,60	2,70	2,75	2,85	2,90	2,95	3,05	3,10	3,20	3,25	3,30	3,40	3,45
3000	2,50	2,55	2,65	2,70	2,80	2,85	2,95	3,00	3,05	3,15	3,20	3,30	3,35	3,45	3,50	3,55
3100	2,60	2,65	2,75	2,80	2,90	2,95	3,05	3,10	3,20	3,25	3,30	3,40	3,50	3,55	3,60	3,70
3200	2,65	2,75	2,80	2,90	2,95	3,05	3,15	3,20	3,30	3,35	3,45	3,50	3,60	3,65	3,75	3,80
3300	2,75	2,85	2,90	3,00	3,05	3,15	3,20	3,30	3,40	3,45	3,55	3,60	3,70	3,80	3,85	3,95
3400	2,85	2,90	3,00	3,10	3,15	3,25	3,30	3,40	3,50	3,55	3,65	3,70	3,80	3,90	3,95	
3500	2,90	3,00	3,10	3,20	3,25	3,30	3,40	3,50	3,60	3,65	3,75	3,85	3,90	4,00		
3600	3,00	3,10	3,15	3,25	3,35	3,45	3,50	3,60	3,70	3,75	3,85	3,95				
3700	3,10	3,20	3,25	3,35	3,45	3,50	3,60	3,70	3,80	3,90	4,00					
3800	3,20	3,30	3,35	3,45	3,55	3,60	3,70	3,80	3,90	4,00						
3900	3,25	3,35	3,45	3,55	3,60	3,70	3,80	3,90	4,00							
4000	3,35	3,45	3,50	3,60	3,70	3,80	3,90	4,00								

↑
Fuel oil EL/diesel fuel