

OIL UP FEEDER 88

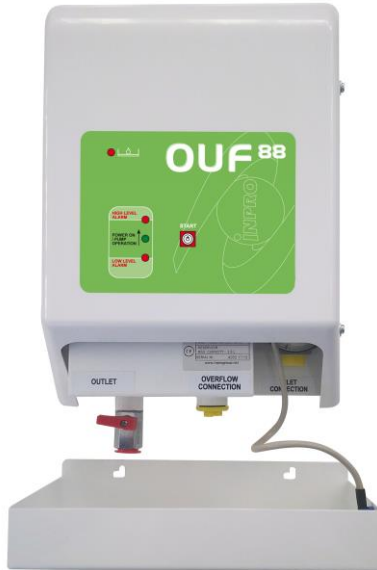

**OUF 88 equipped with optional
leak detection system**

**OUF 88 and OUF 88 Maxi
INSTALLATION MANUAL**

INDEX

OUF88 Technical Specifications	2
OUF 88 Installation	3
Troubleshooting and maintenance	4
Wiring Diagram	5
System description and parts	6
Accessories – Leak detection system	7
Leak detection system wiring diagram	8
Installation examples	9
Display quick reference list	10

OUF 88 – TECHNICAL SPECIFICATIONS

PUMP TYPE	Suction Solenoid Pump	
LIFTING HEIGHT (MAX.)	8 m vertical (8 mm I.D. tube)	
MÁX. HORIZONTAL DISTANCE	100 m horizontal (8 mm I.D.. tube)	
OUTLET FLOW RATING (8 mm I.D. tube)	8 L/hr at: 8 m vertical & 25 m horizontal 15 l/hr at: 5 m vertical & 25 m horizontal	
INLET CONNECTION	3/8 " F BSP	
OUTLET CONNECTION	3/8 " F BSP	
OVERFLOW OUTLET CONNECTION	½ " F BSP	
POWER SUPPLY	AC 230V, 50Hz	
POWER CONSUMPTION	50 W	
RESERVOIR TOTAL CAPACITY	3,5 Litre.	12 Litre
	OUF 88	OUF 88 MAXI
DIMENSIONS: Width:	(240 mm)	(350 mm)
Depth:	(130 mm)	(225 mm)
Height:	(335 mm)	(345 mm)
WEIGHT	3 kg	4 kg
FUEL TYPE	Kerosene & Diesel Oil	

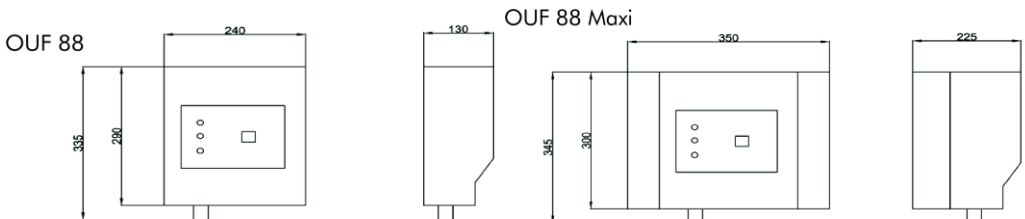

OUF 88 INSTALLATION

🔧 Installation must be in accordance with BS 5410 + any local building regulations

1/ Connect the suction line from the main tank to the 'inlet', and the supply pipe ('gravity fed') to the appliance to the outlet. Connect the overflow facility (*).

If your pipe is in PVC or Copper you are required to use a 10mm pipe insert at any junction that has a compression fitting.

2/ Connect the GPS 10 to the mains supply either through a plug (not included) or fused electric spur (see wiring diagram page 5). The mains supply cable has to pass through the access hole to the back part of the mounting plate
Once powered up, low level led & green power light will come on.

3/ To start the OUF automatic operation, press and keep pressed the start button, which will start the pump, filling the OUF 88 reservoir, until the Low Level lamp turns off.
The pump may be noisy initially until the fuel starts coming through to the pump.

Auto fill mode – Please read before powering the unit.

- Switch on 240v power to the unit
- Within 5 seconds press start button and hold in.
- The OUF 88 will display a light sequence.
- The pump will then start running/sucking.
- Release the start button. The unit is now in automatic mode.
- Whilst in automatic mode the lower 2 leds flash intermittently. (see details P10)

Once reached the low level, you can release the start button, because the OUF works in automatic mode.

4/ Once the oil has filled the OUF 88 reservoir to the programmed maximum level (80% approx), the working level switch will stop the pump.

5/ The OUF is now ready for use and the appliance(s) can be used. The OUF 88 will manage the fuel supply automatically.

(*) The **overflow connection** is dual purpose:

1) It must be connected with a return pipe to the tank as a safety feature in the event that the float switch fails. A leak detector & oil tray are available as an alternative if it is not possible to take the overflow back to the tank. The manufacturer will refuse any liability for damages at any installation without at least one these two additional safety options fitted.

2) It can be connected to the oil tank to allow venting of the OUF88 reservoir if it is required to be sealed to prevent unwanted smells.

If under automatic function, the noise level is not low and stable, that will mean that you have air coming inside the pump: Check suction line vacuum tightness, tube size, and distances related to suction limits of your OUF 88.

If the oil does not come up to the OUF 88:

- Check suction pipe for blockage and/or vacuum tightness.
- Is your vertical lift height lower than 8 mt?
- Check if the filter is clogged/dirty

If the problem still persists:

- Check pump suction power (with a vacuum gauge or by placing your hand at the filter inlet and pressing the start button to see if you can feel suction).
- Check power supply voltage
- Prime the suction line at the OUF 88. Then switch on the pump to pull this oil through and the oil from the tank.
- Check if there is oil at main tank. After 1 hour pumping without oil, the pump will stop itself.

Maintenance:

- Clean regularly the filter bowl and strainer.

Suction curve:

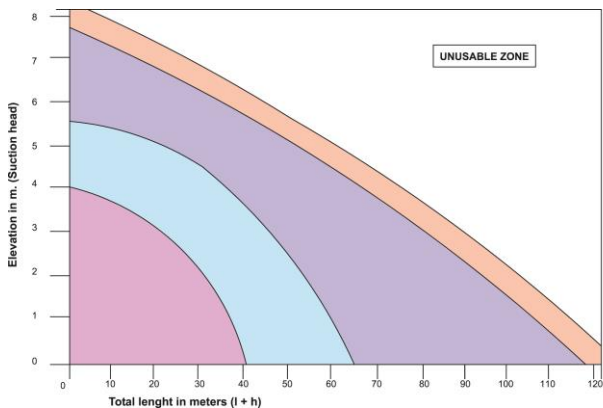

- MAX. FLOW 8 l/h
- MAX. FLOW 10 l/h
- MAX. FLOW 13 l/h
- MAX. FLOW 16 l/h

Light Oil $\left\{ \begin{array}{l} \text{kinematic viscosity} = \varphi_{37} \sim 4 \text{ c St.} \\ \text{density} = \delta_{15} \sim 0,841 \text{ kg/l} \end{array} \right.$

OUF 88 Wiring Diagram

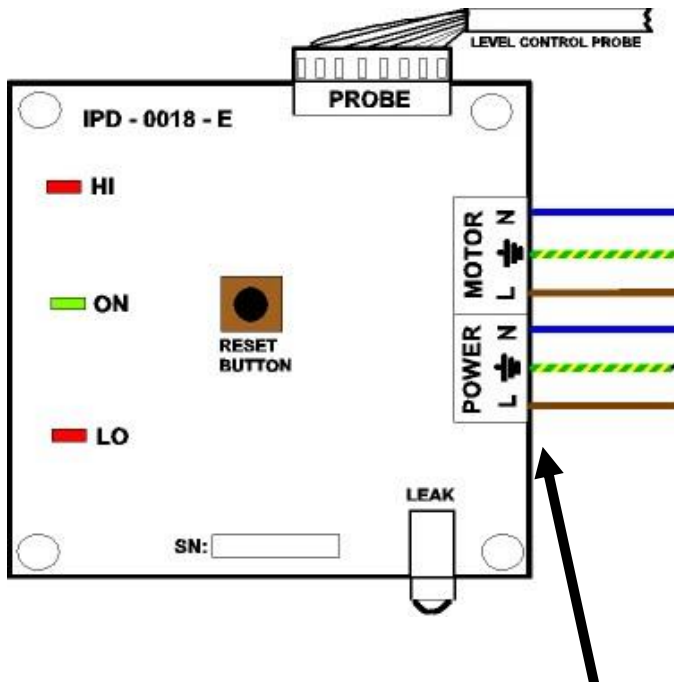

△ **Warning:** Make sure that the ground/earth is properly connected.

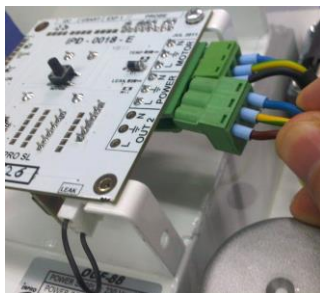

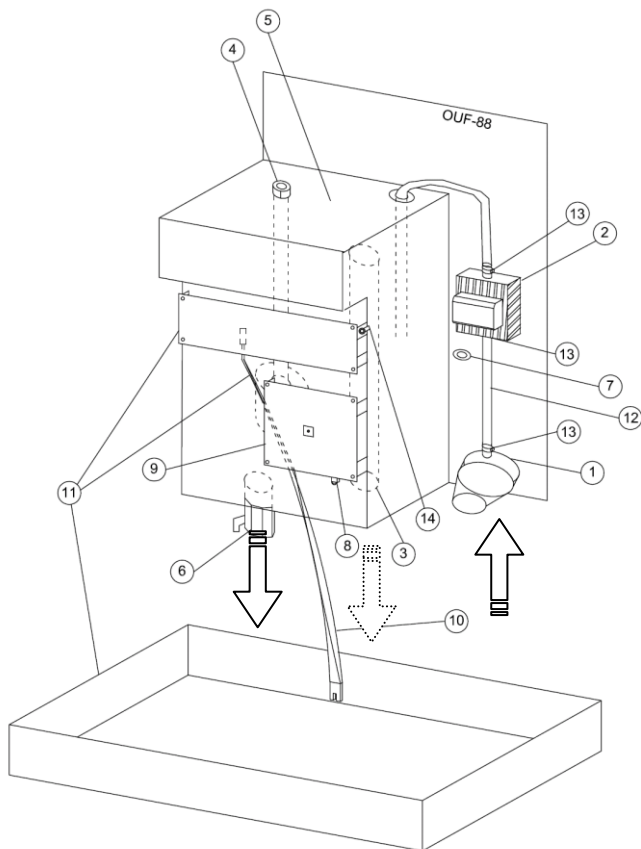

PART DESCRIPTION	Art. Nr.
1. FILTER 3/8 " BSP/ INLET CONNECTION	6800660
2. PUMP	6800651
3. OVERFLOW 1/2 " BSP CONNECTION	-
4. FLOAT SWITCH PROBE	6800656
REPLACEMENT FLOAT IN STAINLESS STEEL	6800655
5. OIL RESERVOIR (3 lts) or (MAXI 12 lts.))	-
6. OUTLET CONNECTION 3/8 " BSP	
7. POWER SUPPLY ACCESS HOLE	-
8. 4 PORTS LINK	6800668
9.- OUF CONTROL CIRCUIT COMPLETE (Ver. E)	6800647
10.- INFRARED PROBE FOR OUF 88, 350 mm long	6800221
11.- LEAK DET. PCB, PROBE & OIL TRAY 24x14x4cm FOR OUF 88	6800232A
12.- TRANSPARENT PIPE	6800652
13.- 1 SIDE COMPRESSED CLIPS 7.8/9.5	6800653
14.- EARH POST	

Oil tray with leak detection system

An oil tray with an infrared leak detection system is available for your OUF.

This optional oil tray is strongly recommended, particularly in the event that the overflow pipe is not connected.

In some regions, the use of the oil tray can be compulsory under certain local standards. Please ask your dealer for details.



How does the leak detection system function

Once installed, the function of your OUF remains unchanged, except when some liquid at the infrared probe activates the system. After a 4 seconds delay -safety against unnecessary stops-:

- The pump stops and the lifter shut down
 - The upper red "high level" led light  comes on

This status will be maintained until the infrared probe is completely clean and dry again.

Once the probe is clean, the system will fill up automatically again, unless low or high level alarm is present.

Installation of the leak detection system:

- 1.- Be sure that the OUF88 unit is not powered
- 2.- Remove the front plastic cover
- 3.- Fix the leak detection 4 pin connector at the L.D. PCB (see Fig. 1)
- 4.- Fix the leak detection PCB with its 4 screws at OUF reservoir (Above control PCB)
- 5.- Connect the power cables according to leak detection wiring diagram (Pag. 8)
- 6.- Place the infrared sensor in the blue clip in the oil tray, at the lowest possible position.
- 7.- Extract the yellow cap at overflow outlet



Fig. 1

OUF 88 with leak detection system. Wiring diagram

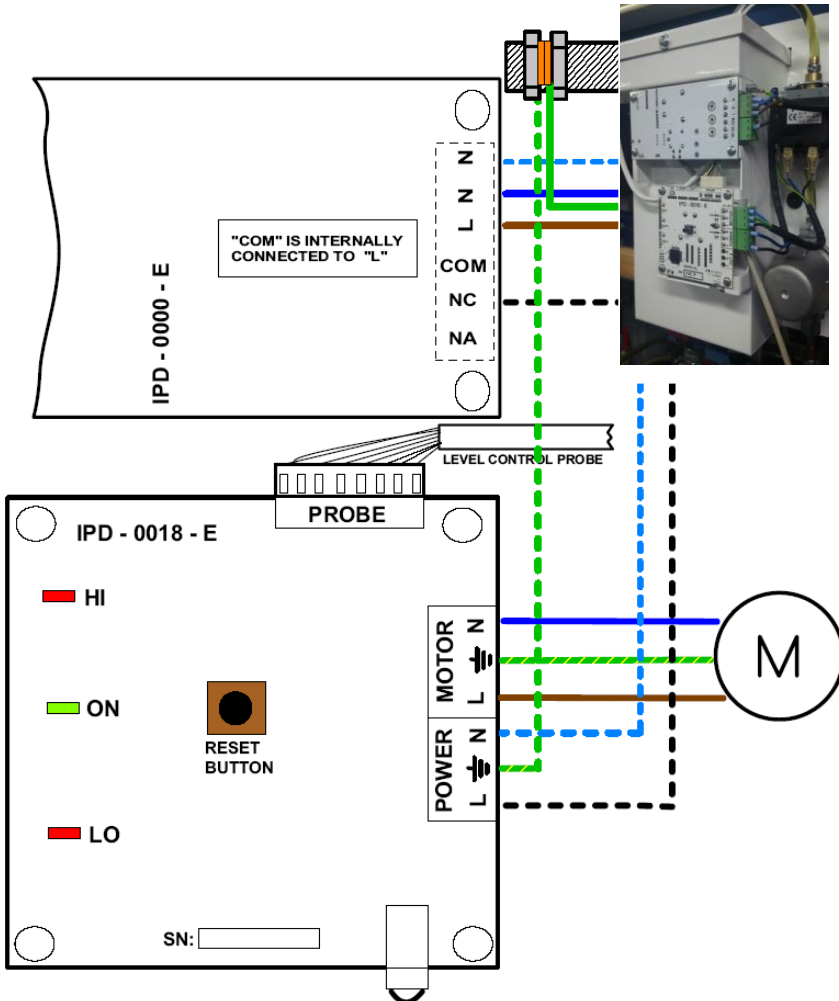

Connections above detailed by dashed line, have to be fitted by the leak detection system installer.

An insulated three wire cable is provided for this purpose.

Note: The  is only operational when the Leak Detector & L.D. Board are fitted.

Installation examples:

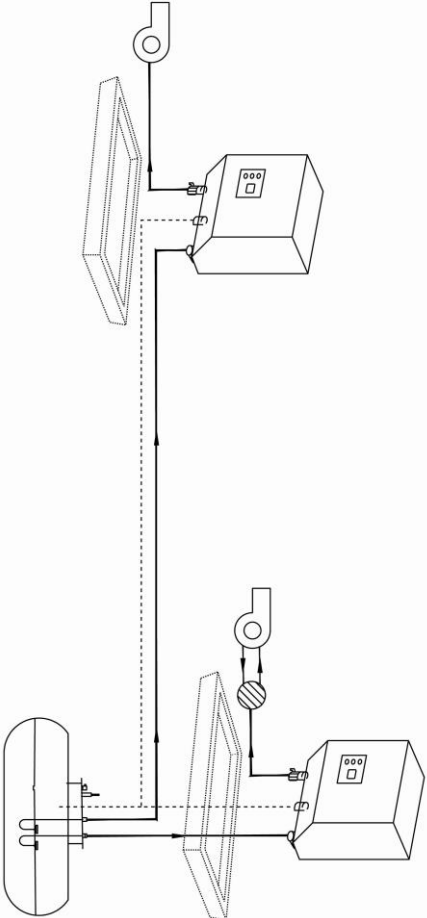
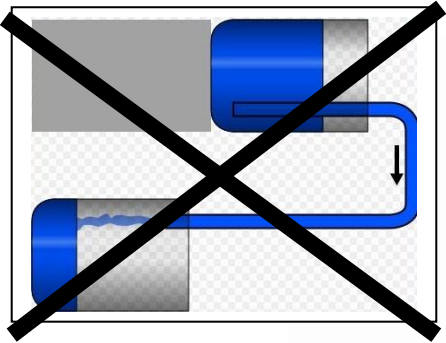

Important:

For outdoor use, a weather-proof protective cabinet must be used for the OUF-88

Do not install below oil level at main tank, as siphoning may occur if no extra device is installed (anti siphon

Display quick reference list

Fix light: 	Flashing Light: 
---	--

Normal Operation Status:

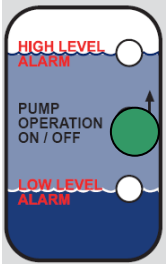

OUF 88 Oil Lifter is powered. Oil in lifter reservoir arrived till stop level. It keeps this state till low level is reached again, or start button is pushed.

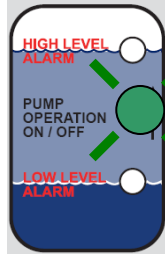

Pump filling OUF reservoir

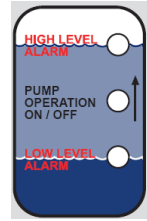

No Power Supply

Alarm Status:

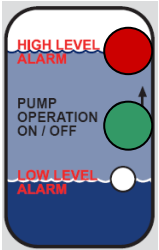

Very high level is reached

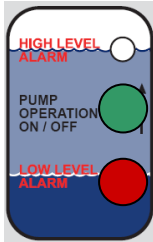

Very low level is reached



+

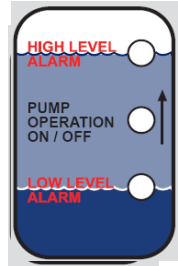

Leak detection alarm (if fitted)

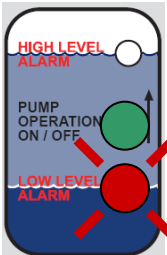

No oil Safety Stop: Activated after 1 hour approx. running without oil

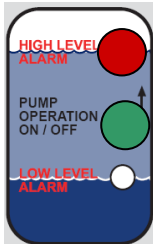

No level probe is detected

Other Status:

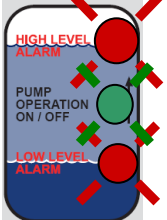

Reset Sequence

Following to an interruption to the power automatically starts within 3 seconds.

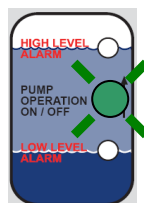

x 5...

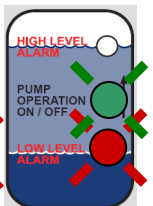
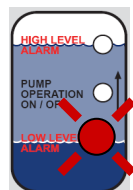

Automatic Start Mode facility

To enter, keep pressing start button during 5 green led blinks (5 sec approx)