

# PIUSI

*Fluid Handling  
Innovation*

## E300

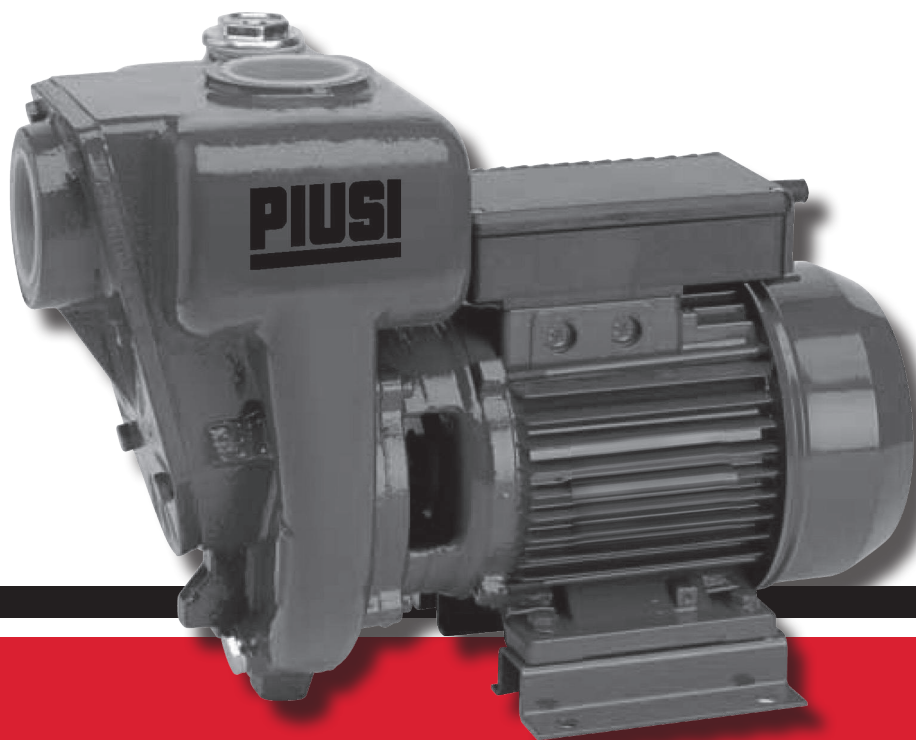

*Installazione, uso e manutenzione* | **IT**

*Instalación, uso y mantenimiento* | **ES**

*Installation, use and maintenance* | **EN**

**MADE  
IN  
ITALY**

**BULLETIN MO362 A ML \_oo**

---

# ENGLISH

---

EN

**BULLETIN MO362 A ML** IT | ES | EN

**A INDEX**

---

A	INDEX	38
B	MACHINE AND MANUFACTURER IDENTIFICATION	39
C	DECLARATION OF CONFORMITY	39
D	MACHINE DESCRIPTION	40
	D1 HANDLING AND TRANSPORT	40
	D2 PACKAGING	40
E	GENERAL WARNINGS	41
F	FIRST AID RULES	41
G	GENERAL SAFETY RULES	42
H	TECHNICAL SPECIFICATIONS	43
I	OPERATING CONDITIONS	44
	I1 ENVIRONMENTAL CONDITIONS	44
	I2 POWER CONSUMPTION	44
	I3 WORKING CYCLE	44
	I4 PERMITTED AND NON-PERMITTED FLUIDS	44
L	INSTALLATION	45
	L1 ASSEMBLY	45
	L2 HYDRAULIC CONNECTION	45
	L3 CONSIDERATIONS REGARDING DELIVERY AND SUCTION LINES	47
	L4 LINE ACCESSORIES	47
	L5 ELECTRICAL CONNECTIONS	48
M	INITIAL START-UP	49
N	START-UP AND EVERY DAY USE	50
	N1 GENERAL INFORMATION	50
	N2 EVERY DAY USE	50
	N3 NO POWER SUPPLY	50
O	NOISE LEVEL	50
P	MAINTENANCE	51
Q	PROBLEMS AND SOLUTIONS	51
R	DEMOLITION AND DISPOSAL	52
S	EXPLODED VIEW	53

## B MACHINE AND MANUFACTURER IDENTIFICATION



Available models  
MANUFACTURER

**E300**  
PIUSI S.p.A  
Via Pacinotti c.m. z.i.Rangavino  
46029 Suzzara - Mantova - Italy

ATTENTION



**Before installing, always make sure the unit is correct and suitable for the available power supply (Voltage/Frequency).**

## C DECLARATION OF CONFORMITY

The undersigned: PIUSI S.p.A  
Via Pacinotti c.m. z.i.Rangavino  
46029 Suzzara - Mantova - Italy

Serial number: refer to Lot Number shown on CE plate affixed to product  
Year of manufacture: refer to the year of production shown on the CE plate affixed to the product  
is in conformity with the legal provisions indicated in the directives :

- **Machine Directive 2006/42/EC**
- **Electromagnetic Compatibility Directive 2004/108/EC**

The documentation is at the disposal of the competent authority following motivated request at Piusi S.p.A. or following request sent to the email address: doc\_tec@piusi.com  
The person authorised to compile the technical file and draw up the declaration is Otto Varini as legal representative.

Suzzara 01/01/2015

Otto Varini  
legal representative.

## D MACHINE DESCRIPTION

**PUMPA  
MOTOR**

Mono block self-priming electric pumps with open impeller.  
2-pole induction electric motor (n=2850 min<sup>-1</sup>)

### D1 HANDLING AND TRANSPORT

Whenever the pump is raised, check that the capacity of the lifting devices and accessories (e.g. bands) is suitable. Any mechanical devices for handling and lifting should be operated only by qualified and suitably trained personnel.

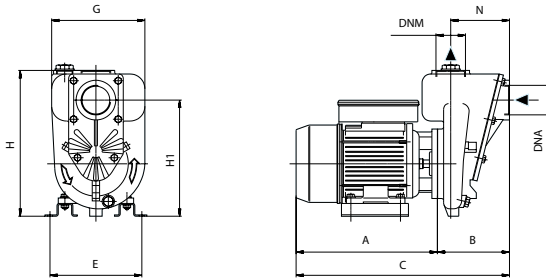

TYPE	DIMENSIONS										DIMENSION			WEIGHT	
	A	B	C	E	G	H	H1	N	DNA	DNM	P	L	H		Kg
<b>SINGLE PHASE</b>															
<b>E300</b>	260	152	412	185	193	302	240	122	2"	2"	220	420	330	28	

### D2 PACKAGING

**FOREWORD**

E300 comes packed in a cardboard box with a label indicating the following data:

- 1 - contents of the package
- 2 - weight of the contents
- 3 - description of the product

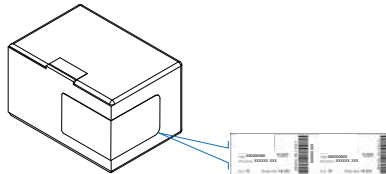

## E GENERAL WARNINGS

<b>Important precautions</b>	To ensure operator safety and to protect the pump from potential damage, workers must be fully acquainted with this instruction manual before performing any operation.
<b>Symbols used in the manual</b>	The following symbols will be used throughout the manual to highlight safety information and precautions of particular importance: <b>ATTENTION</b> <i>This symbol indicates safe working practices for operators and/or potentially exposed persons.</i> <b>WARNING</b> <i>This symbol indicates that there is risk of damage to the equipment and/or its components.</i> <b>NOTE</b> <i>This symbol indicates useful information.</i>
<b>Manual preservation</b>	This manual should be complete and legible throughout. It should remain available to end users and specialist installation and maintenance technicians for consultation at any time.
<b>Reproduction rights</b>	All reproduction rights are reserved by Piusi S.p.A. The text cannot be reprinted without the written permission of Piusi S.p.A. © Piusi S.p.A. THIS MANUAL IS THE PROPERTY OF Piusi S.p.A. <b>ANY REPRODUCTION, EVEN PARTIAL, IS FORBIDDEN.</b> This manual belongs to Piusi S.p.A., which is the sole proprietor of all rights indicated by applicable laws, including, by way of example, laws on copyrights. All the rights deriving from such laws are reserved to Piusi S.p.A.: the reproduction, including partial, of this manual, its publication, change, transcription and notification to the public, transmission, including using remote communication media, placing at disposal of the public, distribution, marketing in any form, translation and/or processing, loan and any other activity reserved by the law to Piusi S.p.A..



## F FIRST AID RULES

<b>ATTENTION</b> <b>Contact with the product</b>		In the event of problems developing following EYE/SKIN CONTACT, INHALATION or INGESTION of the treated product, please refer to the SAFETY DATA SHEET of the fluid handled.
<b>NOTE</b>		Please refer to the safety data sheet for the product
<b>SMOKING PROHIBITED</b>		When operating the dispensing system and in particular during refuelling, do not smoke and do not use open flame.
<b>Persons who have suffered electric shock</b>		Disconnect the power source, or use a dry insulator to protect yourself while you move the injured person away from any electrical conductor. Avoid touching the injured person with your bare hands until he is far away from any conductor. Immediately call for help from qualified and trained personnel. Do not operate switches with wet hands.

## G GENERAL SAFETY RULES

**Essential protective equipment characteristics**

Wear protective equipment that is: suited to the operations that need to be performed; resistant to cleaning products.

**Personal protective equipment that must be worn**



Wear the following personal protective equipment during handling and installation: safety shoes;



close-fitting clothing;



protective gloves;



safety goggles;

**Other equipment**



instruction manual

**Protective gloves**



Prolonged contact with the treated product may cause skin irritation; always wear protective gloves during dispensing.

**WARNING**



**Never touch the electric plug or socket with wet hands.**

**Do not switch the dispensing system on if the network connection cable or important parts of the apparatus are damaged, such as the inlet/outlet pipe, nozzle or safety devices. Replace the damaged pipe immediately.**

**Before each use, check that the network connection cable and power plug are not damaged. Have the network connection cable replaced immediately by a qualified electrician.**

**ATTENTION**



**The electrical connection between the plug and socket must be kept well away from water.**

**Unsuitable extension leads can be dangerous. In accordance with current regulations, only extension cords that are labelled for outdoor use and have a sufficient conduction path should be used outdoors.**

**For safety reasons, we recommend that, in principle, the equipment be used only with an earth-leakage circuit breaker (max 30 mA).**

**In case of a fault of the pump, repair works can only be made by repair workshops of the technical support. Only original spare parts must be used.**

**BE AWARE THAT, PURSUANT TO PRODUCT LIABILITY LAW, WE SHALL NOT BE RESPONSIBLE FOR DAMAGES CAUSED BY OUR EQUIPMENT:**

- 1 **For improper repairs which are not made by the personnel of the service points authorized by us**
  - 2 **If original spare parts are not used.**
  - 3 **If the indications and provisions in this instruction manual are not observed.**
- The same conditions shall apply to accessories.**

# H TECHNICAL SPECIFICATIONS

## H1 ELECTRICAL DATA

POWER			POWER	CURRENT	RPM
POWER	Voltage (V)	Frequency (Hz)	Nominal (Watt)	Max (Amp)	Nominal (rev./m)
AC	230	50	1500	9.3	2580

## H2 PERFORMANCE

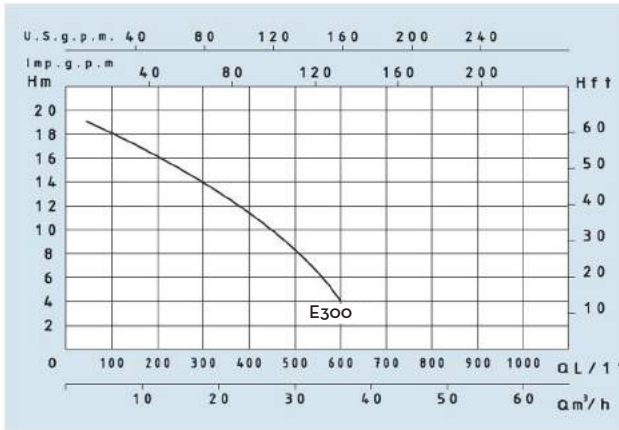

TYPE	NOMINAL POWER P <sub>2</sub>		ABSORBED POWER P <sub>1</sub>	AMPERE	Q = FLOW RATE												
	HP	kW			kW	SINGLE-PHASE	M <sup>3</sup> /h	1.5	3	6	12	18	24	36	48	60	72
230 V - 50 Hz					SINGLE-PHASE	lt./min.	25	50	100	200	300	400	600	800	1000	1200	
E300	2	1.5	2	9.3	1 x 230 V	TOTAL GAUGE HEAD IN m.c.A.											
					H (m)		19	18	16	14	11	4					





# I OPERATING CONDITIONS

## I1 ENVIRONMENTAL CONDITIONS

TEMPERATURE	min. 20 °C / max +60 °C
RELATIVE HUMIDITY	max. 90%
LIGHTING	<i>The environment must conform to directive 89/654/EEC on work environments. In case of non-EU countries, refer to directive EN ISO 12100-2 § 4.8.6.</i>

ATTENTION



*The temperature limits shown apply to the pump components and must be respected to avoid possible damage or malfunction.*

## I2 POWER CONSUPTION

NOTA



Depending on the model, the pump must be fed by single-phase alternating current whose nominal values are those indicated in the Table.  
 The maximum acceptable variations from the electrical parameters are:  
 Voltage: +/- 5% of the nominal value  
 Frequency: +/- 2% of the nominal value

ATTENTION



*Power from lines with values outside the indicated limits can damage the electrical components.*

## I3 WORKING CYCLE

NOTE



The motors are intended for continuous use. Under normal operating conditions they can function continuously with no limitations

## I4 PERMITTED AND NON-PERMITTED FLUIDS

PERMITTED FLUIDS	DIESEL WITH A VISCOSITY BETWEEN 2 AND 5.35 cST (AT A TEMPERATURE OF 37.8 °C) MINIMUM FLASH POINT (PM): 55 °C Ref: EN5902010 dtd. 25/03/2010
NON PERMITTED FLUIDS	ALL THE FLUIDS NOT MENTIONED IN "ADMITTED FLUIDS"

## L INSTALLATION

### L1 ASSEMBLY

**ATTENTION  
PRELIMINARY  
INSPECTION**



*The pump must never be operated before the delivery and suction lines have been connected.*

- *Verify that all components are present. Request any missing parts from the manufacturer.*
- *Check that the pump has not suffered any damage during transport or storage*
- *Carefully clean the suction and delivery inlets and outlets, removing any dust or other packaging material that may be present*
- *Check that the electrical data corresponds to those indicated on the data plate*

**ATTENTION**



**THE MOTORS ARE NOT OF THE ANTI-EXPLOSIVE-TYPE.**

**POSITIONING**

For detailed machine assembly instructions, refer to the exploded view:

For machine assembly and installation, always keep the same position indicated on the exploded diagram in this manual.

Take care to ensure that the unit is installed in a well-ventilated and illuminated environment.

The pump can be installed in any position (pump axis vertical or horizontal)

Attach the pump using screws of adequate diameter for the attachment holes provided in the bracket of the pump (see section "OVERALL DIMENSIONS" for their position and dimension).

### L2 HYDRAULIC CONNECTION

**NOTE**



Before connecting, make sure that the hoses and the suction tank are free of dirt and thread residue, which could damage the pump and accessories.

**ATTENTION**



Before connecting the delivery hose, partially fill the pump body with the liquid that needs to be pumped (do not allow the pump to run dry during the priming stages).

**ATTENTION**



**Do not use conical threaded joints that could damage the threaded pump openings if excessively tightened.**

The MINIMUM recommended characteristics for hoses are as follows:

**SUCTION HOSE**

- Install the suction hose in ascending position towards the pump. Do not install the suction hose beyond the pump height (air bubbles in the suction hose).
- Install the suction hose so as not to exert any mechanical pressure on the pump.
- The suction valve must be located at least 30 cm under the fluid level.
- Non-airtight suction hoses suck air and prevent the fluid from being sucked.
- Minimum nominal diameter: 2"
- Nominal recommended pressure: 10 bar
- Use tubing suitable for functioning under suction pressure.

**DELIVERY HOSE**

- Install the delivery hose so as not to exert any mechanical pressure on the pump.
- Minimum nominal diameter: 2"
- Nominal recommended pressure: 10 bar

**ATTENTION**



***During the suction phase, the stop components (nozzles, valves etc.) in the delivery hose should be fully opened, so that the air in the suction hose is freely removed.***

**ATTENTION**



***It is the responsibility of the installer to provide the necessary line accessories to ensure the correct and safe operation of the pump. The accessories that are not suitable to be used with the previously indicated material could damage the pump and/or cause injury to persons, as well as causing pollution.***

***Loosening of the connections (threaded connections, flanges, gasket seals) could cause serious ecological and safety problems. Check all the connections after the first installation and, subsequently, check on a weekly basis. If necessary, tighten all the connections.***

***To maximise performance and prevent damage that could affect pump operation, always demand original accessories.***

During initial start-up or accidental draining of the pump, fill the oil sump directly through the suction inlet of the pump. At the end of the operation, remember to connect the hose to the suction inlet.

When connecting the delivery and suction hoses, use the correct fittings (not supplied with the unit) with thread seal.

### L3 CONSIDERATIONS REGARDING DELIVERY AND SUCTION LINES

#### DELIVERY

The choice of pump model to use should be made keeping in mind the viscosity of the oil to be pumped and the characteristics of the system attached to the delivery of the pump. The combination of the oil viscosity and the characteristics of the system could, in fact, create back pressure greater than the anticipated maximums (equal to  $P_{max}$ ), so as to cause the (partial) opening of the pump by-pass with a consequent noticeable reduction of the flow rate supplied.

In such a case, in order to permit the correct functioning of the pump equal to the viscosity of the oil being pumped, it will be necessary to reduce resistance in the system by employing shorter hoses and/or of larger diameter. On the other hand, if the system cannot be modified it will be necessary to select a pump model with a higher  $P_{max}$ .

#### SUCTION

High suction pressure values lead to cavitation phenomena with high operation noise that over time can cause pump damage, as well as lower pump performance.

In any case, for as much as was said above, it is important to guarantee low suction pressures (short hoses and possibly of larger diameter than the suction inlet of the pump, fewer bends, wide section filters and kept clean).

#### ATTENTION



***It is a good system practice to immediately install vacuum and air pressure gauges at the inlets and outlets of the pump which allow verification that operating conditions are within anticipated limits. To avoid emptying the suction hose when the pump is turned off, the installation of a foot valve is recommended.***

### L4 LINE ACCESSORIES

#### ATTENTION



***It is the installer's responsibility to provide the line accessories necessary for the safe and proper functioning of the pump. The use of accessories unsuitable for use with diesel fuel can damage the pump, injure persons and cause pollution.***

***Pumps are supplied without electrical safety devices such as fuses, motor protectors, and systems to prevent accidental restarting after periods of power failure or any other kind. It is the installer's responsibility to carry out the electrical connection with respect to the applicable regulations***

***IT IS THE INSTALLER'S RESPONSIBILITY TO CARRY OUT THE ELECTRICAL CONNECTIONS IN COMPLIANCE WITH THE RELEVANT STANDARDS.***

## L5 ELECTRICAL CONNECTIONS

### FOREWORD

The electrical connections must be performed in a workmanlike manner by skilled personnel, respecting the regulations in effect in the country of installation. To make the necessary connections, refer to the electrical wiring diagram in this manual.

### ATTENTION



Respect the following (not exhaustive) instructions to ensure a proper electrical installation:

### DIRECTION FOR CORRECT ELECTRICAL INSTALLATION

- During installation and maintenance make sure that power to the electric lines has been turned off.
- Employ cables characterized by minimum cross-sections, rated voltages and installation type adequate to the characteristics indicated in paragraph ELECTRICAL SPECIFICATIONS and the installation environment.
- All motors are equipped with a ground terminal to connect to the ground line of the electrical network
- Always close the cover of the terminals trip box before turning on the electric power, after checking the integrity of the gasket seals.

**The unit is not equipped with circuit breakers. It is therefore recommended to install a 30-mA residual current operated circuit breaker on the plug. Protection: minimum 10 Amp.**

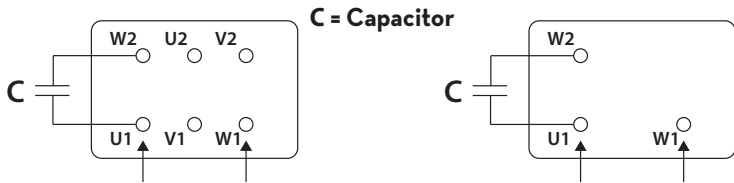





### ATTENTION



**Single-phase motors are supplied with a bipolar switch and capacitors wired and installed inside the terminal strip box (see chart). The capacitor characteristics are those indicated on the pump label. The switch has the function of starting/stopping the pump and cannot in any way replace the main power switch required by the applicable regulations.**

## M INITIAL START-UP

<b>FOREWORD</b>		The pump E300 are self-priming and, therefore, able to draw oil from the tank even when the suction hose is empty on start-up. The priming height (distance between the surface of the oil and the inlet opening) must not exceed 2,5 meters. - Check that the quantity of fluid in the suction tank is greater than the amount you wish to transfer. - Make sure that the piping and line accessories are in good condition. - Do not run the pump dry. This can cause serious damage to its components. - Do not operate switches with wet hands.
<b>ATTENTION</b>		<b>Fluid leaks can damage objects and injure persons.</b>
<b>NOTE</b>		- Never start or stop the pump by connecting or cutting out the power supply. - Prolonged contact with oil can damage the skin. The use of goggles and gloves is recommended.
<b>NOTE</b>		It is recommended to use a suitable preliminary filter and a suction kit equipped with hose and foot valve (flow stop) to avoid long suction times and a useless damage of the pump caused by solid foreign objects incidentally sucked.
<b>ATTENTION</b>		In the priming phase the pump must relieve the air initially present in the entire installation out of the delivery line. Therefore keep the outlet open to allow the air to be relieved. If an automatic dispensing nozzle is installed at the end of the delivery line, the air relief may be difficult because of the automatic stopping device that keeps the valve closed when the line pressure is too low. It is recommended that the automatic nozzle be temporarily removed during initial start-up.
<b>The priming phase may last from several seconds to a few minutes, depending on the characteristics of the system. If this phase is excessively prolonged, stop the pump and verify:</b>		
		- that the pump is not running completely "dry".
		- that the suction hose guarantees against air infiltration and is correctly immersed in the fluid to be drawn.
		- that the delivery hose allows for the easy evacuation of the air.
		- that the pump is under head
Verify that the pump is functioning within the anticipated ranges, possibly checking:		
1		That under conditions of maximum back pressure, the power absorption of the motor stays within the values shown on the identification plate
2		That the suction pressure does not exceed the limits indicated in paragraph CONSIDERATIONS REGARDING SUCTION & DELIVERY LINES
3		That the back pressure in the delivery line does not exceed the values indicated in paragraph CONSIDERATIONS REGARDING SUCTION & DELIVERY LINES.

## N START-UP AND EVERY DAY USE

### N1 GENERAL INFORMATION

**FOREWORD**

Make sure that the hoses and line accessories are in good condition. Oil leaks can damage objects and injure persons.

Extreme operating conditions can raise the motor temperature and, consequently, cause the thermal protection switch to stop it.

Switch off the unit and wait for it to cool down before using again. The thermal protection automatically turns off when the motor is sufficiently cool.

**ATTENTION**



**Before starting up the system, make sure that the unit has been assembled correctly, with all lids correctly closed.**

### N2 EVERY DAY USE

- 1 Supply voltage to the system by connecting the plug to the mains
- 2 If flexible pipes are used, attach the ends of the piping to the tanks. In the absence of an appropriate slot, solidly grasp the end of delivery pipe before beginning dispensing.
- 3 Before starting the pump make sure that the delivery valve is closed (dispensing nozzle or line valve).
- 4 Turn the ON/OFF switch on.
- 5 Open the delivery valve, solidly grasping the end of the tubing.
- 6 Close the delivery valve to stop dispensing.
- 7 When dispensing is finished, turn off the pump.

**ATTENTION**



**Operation with delivery closed is only allowed for short periods (2 to 3 minutes maximum). After use, make sure the pump is turned off.**

### N3 NO POWER SUPPLY

**NOTE**



An electric power failure, with the consequent accidental stopping of the unit, can be caused by:

- safety device tripping (if present at the system inlet)
- drop in line voltage
- fuse burnt out

## O NOISE LEVEL

Under normal operating conditions noise emission for all models does not exceed the value of 70 dB "A" at a distance of 1 Meter from the electric pump.

## P MAINTENANCE

**Foreword** The unit is designed and built to require a minimum of maintenance. In any case always remember the following basic recommendations to ensure a good functioning of the unit:  
In case of frost risk, empty the pump completely.

Before a long period of inactivity, empty the pump, rinse it with water and store it in a dry place. Before restarting it, check its correct operation by turning it on and off shortly. Afterwards fill the pump with delivery fluid and prepare it for use.

**ATTENTION**



**DISCONNECT THE HYDRAULIC POWER DURING ANY MAINTENANCE OPERATION ON THE UNIT**

## Q PROBLEMS AND SOLUTIONS

PROBLEM	CAUSE	SOLUTION
THE MOTOR DOES NOT START	No mains voltage	Check the voltage
	Pump impeller locked	Remove the hydraulic part and check if the impeller is free to rotate. Reinstall carefully
	Thermostat disconnected	
THE PUMP DOES NOT SUCK	Suction valve outside the fluid	Place the valve into the fluid (minimum 30 cm below the level)
	Pump chamber without fluid	Pour the fluid into the suction fitting
	Air in the suction hose	Check the seal of suction hose
	No hermetic suction valve	Clean the suction tube
	Dirty suction filter	Clean the filter
	Maximum suction height exceeded	Check suction height
INSUFFICIENT FLOW-RATE	Suction height too high	Check suction height
	Dirty suction filter	Clean the filter
	Fluid level lowers quickly	Place suction valve lower
	Pump flow-rate reduced by foreign objects	Clean the pump and replace worn parts
THE THERMAL SWITCH TURNS OFF THE PUMP	Overload motor. Too much friction caused by foreign objects	Remove foreign objects Wait until thermal protection switch trips again

If the fault cannot be removed, contact the authorised service department nearest to you. To avoid any damage during transport, PLEASE CARRY OUT THE SHIPMENT WITH ORIGINAL PACKAGING.





## R DEMOLITION AND DISPOSAL

**Foreword**

If the system needs to be disposed, the parts which make it up must be delivered to companies that specialize in the recycling and disposal of industrial waste and, in particular:

**Disposing of packing materials**

The packaging consists of biodegradable cardboard which can be delivered to companies for normal recycling of cellulose.

**Metal Parts Disposal**

Metal parts, whether paint-finished or in stainless steel, can be consigned to scrap metal collectors.

**Disposal of electric and electronic components**

These must be disposed of by companies that specialize in the disposal of electronic components, in accordance with the indications of directive 2012/19/UE (see text of directive below).

**Information regarding the environment for clients residing within the European Union**



European Directive 2012/19/UE requires that all equipment marked with this symbol on the product and/or packaging not be disposed of together with non-differentiated urban waste. The symbol indicates that this product must not be disposed of together with normal household waste. It is the responsibility of the owner to dispose of these products as well as other electric or electronic equipment by means of the specific refuse collection structures indicated by the government or the local governing authorities.

Disposing of RAEE equipment as household wastes is strictly forbidden. Such wastes must be disposed of separately.

Any hazardous substances in the electrical and electronic appliances and/or the misuse of such appliances can have potentially serious consequences for the environment and human health.

In case of the unlawful disposal of said wastes, fines will be applicable as defined by the laws in force.

**Miscellaneous parts disposal**

Other components, such as pipes, rubber gaskets, plastic parts and wires, must be disposed of by companies specialising in the disposal of industrial waste.

## S EXPLODED VIEW

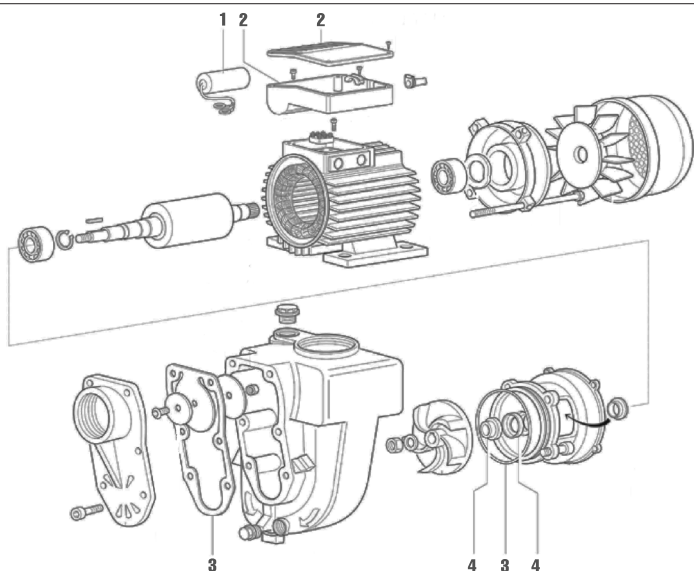





© PIUSI S.p.A.

**IT.** Il presente documento è stato redatto con la massima attenzione circa la precisione dei dati in esso contenuti. Tuttavia, PIUSI S.p.A. non si assume responsabilità per eventuali errori ed omissioni.

**ES.** El presente documento ha sido redactado prestando la máxima atención a la precisión de los datos en él contenidos. PIUSI S.p.A. no se hace responsable de posibles errores y omisiones.

**EN.** This document has been drawn up with the greatest attention to precision and accuracy of all data herein contained. Nevertheless, PIUSI S.p.A. denies liability for any possible mistake or omission.



*Fluid Handling  
Innovation*

**piusi.com**  
PIUSI SpA • Suzzara MN Italy

---

**BULLETIN MO362 A ML \_oo**